

THE UNIFIED PHYSICS OF MEANING

A dynamical theory of repair, collapse, and the geometry of institutional memory.

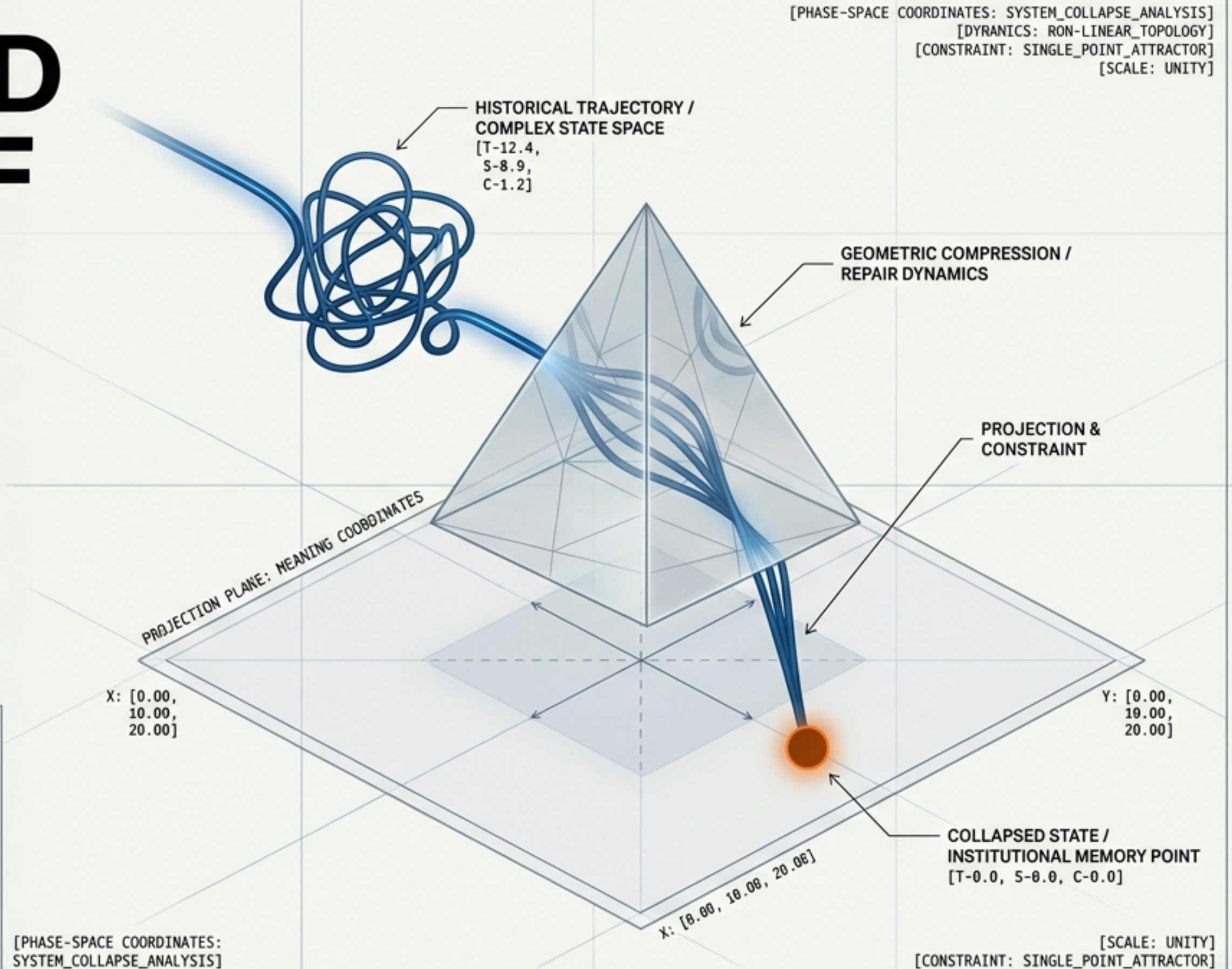

Civilization Preserves Nouns and Loses Verbs

The Artifact-Process Funnel

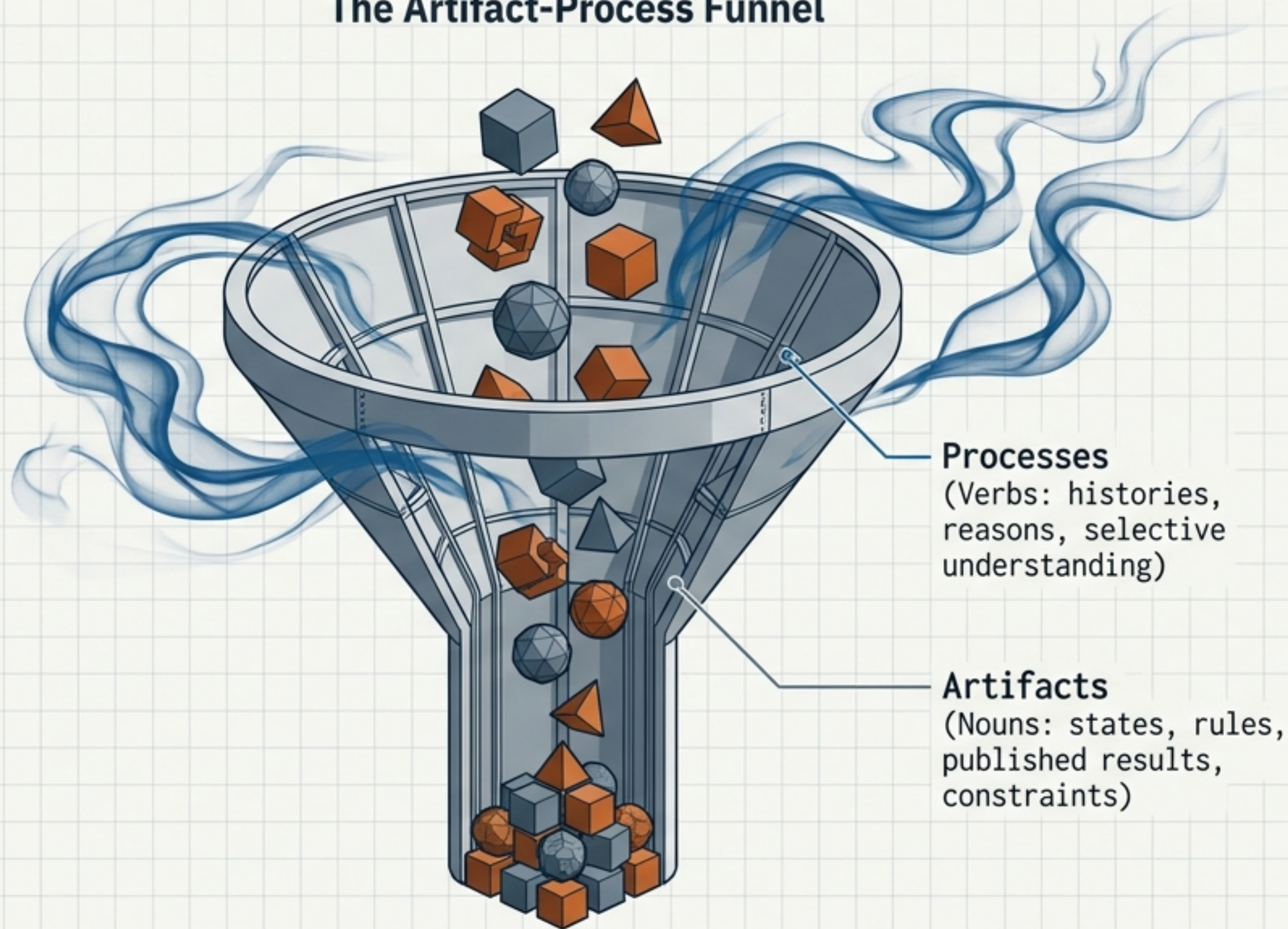

The Core Axiom

The products of a process are easier to store, transmit, and measure than the process itself.

The Consequence

We preserve states efficiently, but trajectory reconstructability decays without massive energy expenditure.

History is Ontologically Prior to State

The **State Illusion**: We mistakenly identify value with a terminal configuration rather than the historical trajectory that produced it. If history is what is lost, **history must be what is preserved**.

The Visual Proof

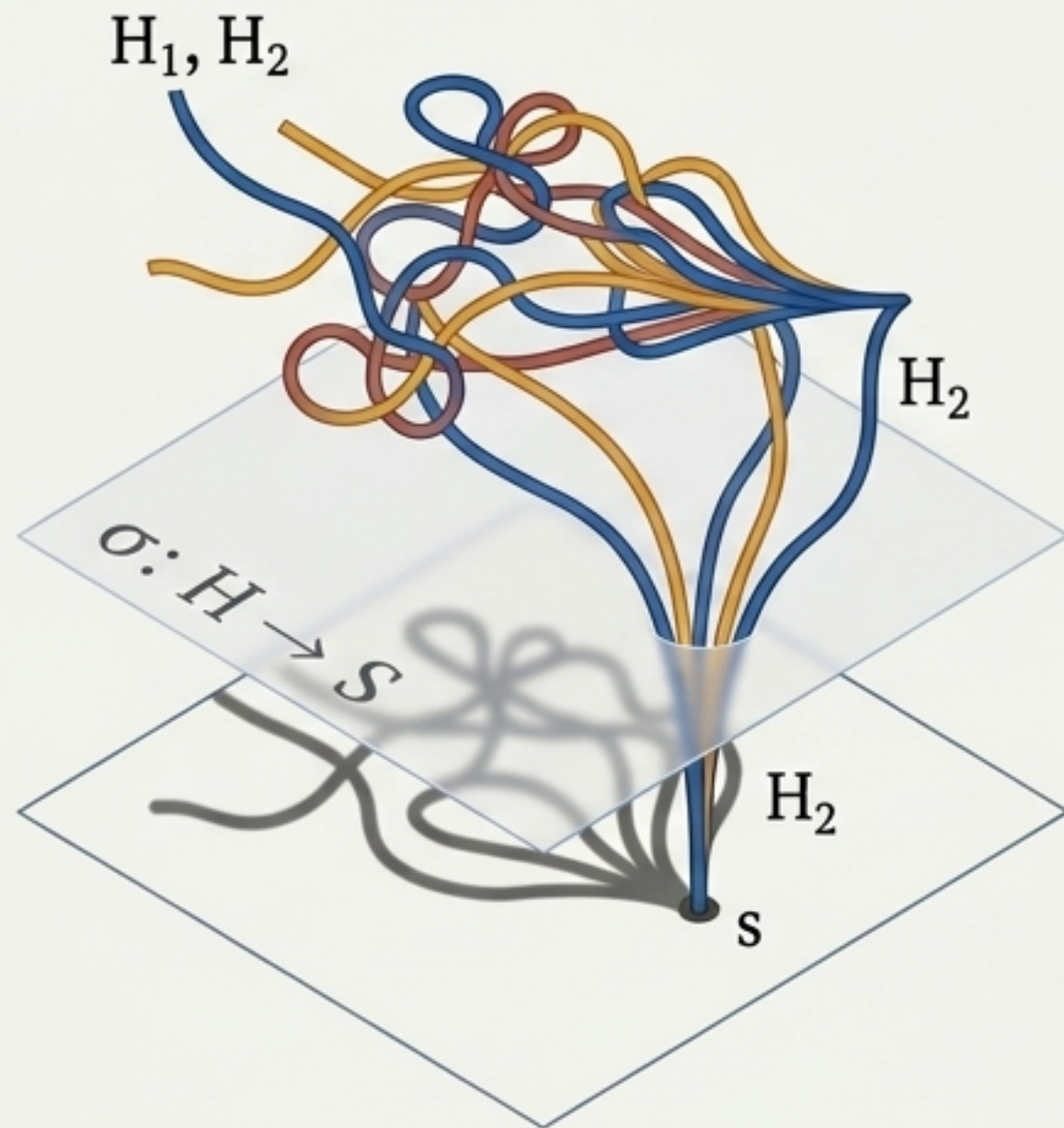

The Paradigm Shift Matrix

	State (Old World)	History (Spherepop)
Core Unit	Value at a Location	Event Trajectory
Identity	Current Configuration	Unique Factorization of Path
Bug Origins	Race Conditions, Use-after-free	Inadmissible Paths
Garbage Collection	Structural Unreachability	Admissibility-guided Collapse
Compiler Truth	Output Equivalence	Replay Equivalence
Error Handling	Unwinding / Crashes	Certified Refusal

Truth is Not a Survival Mechanism

The Economic Reality: A distinction doesn't survive because it's true; it survives because **someone pays the maintenance cost.** Institutions must stop asking "Is this true?" and begin asking "**Who is paying the maintenance topology for this to exist?**"

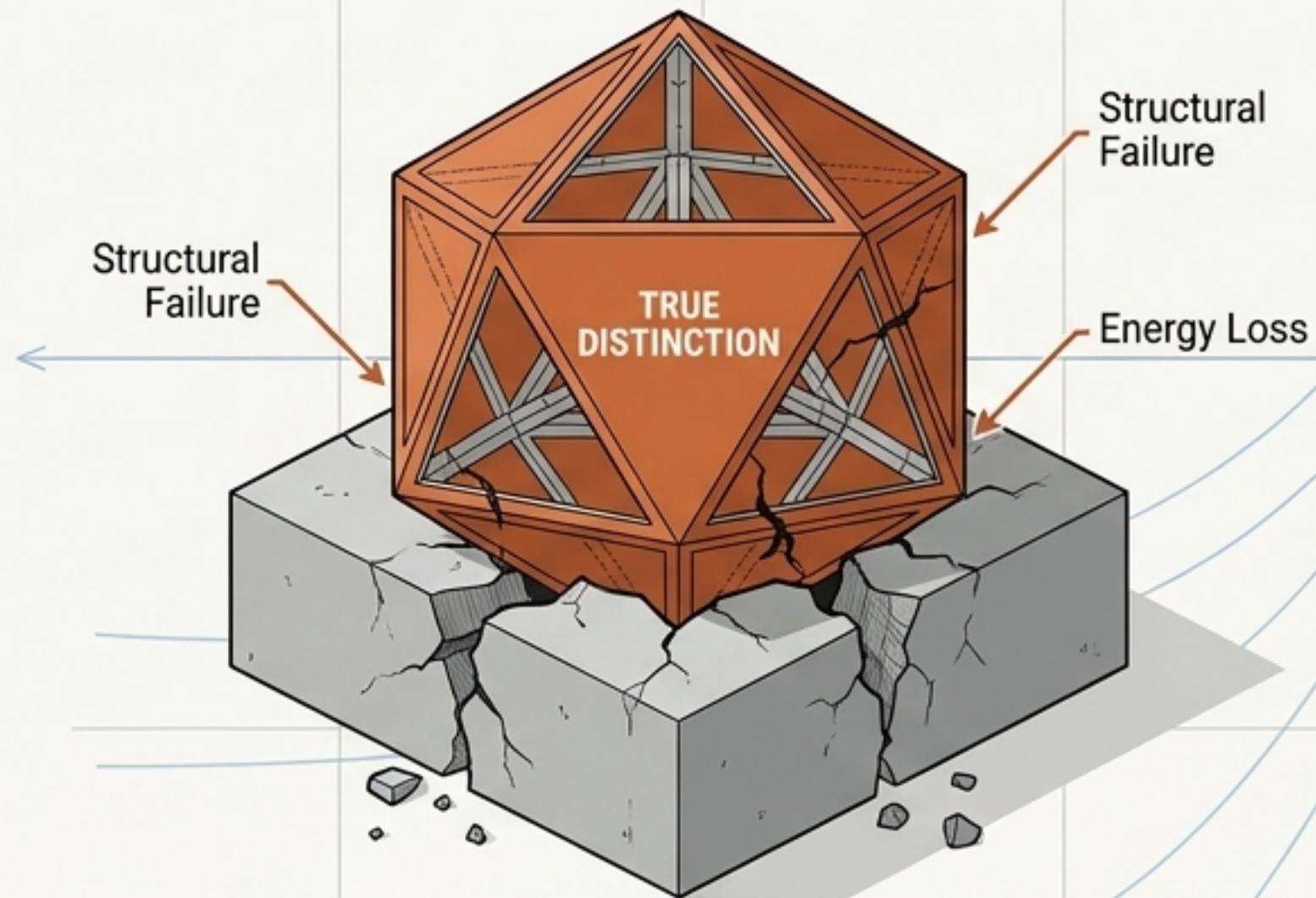

The True & Dead: If no population pays to maintain it, it collapses.

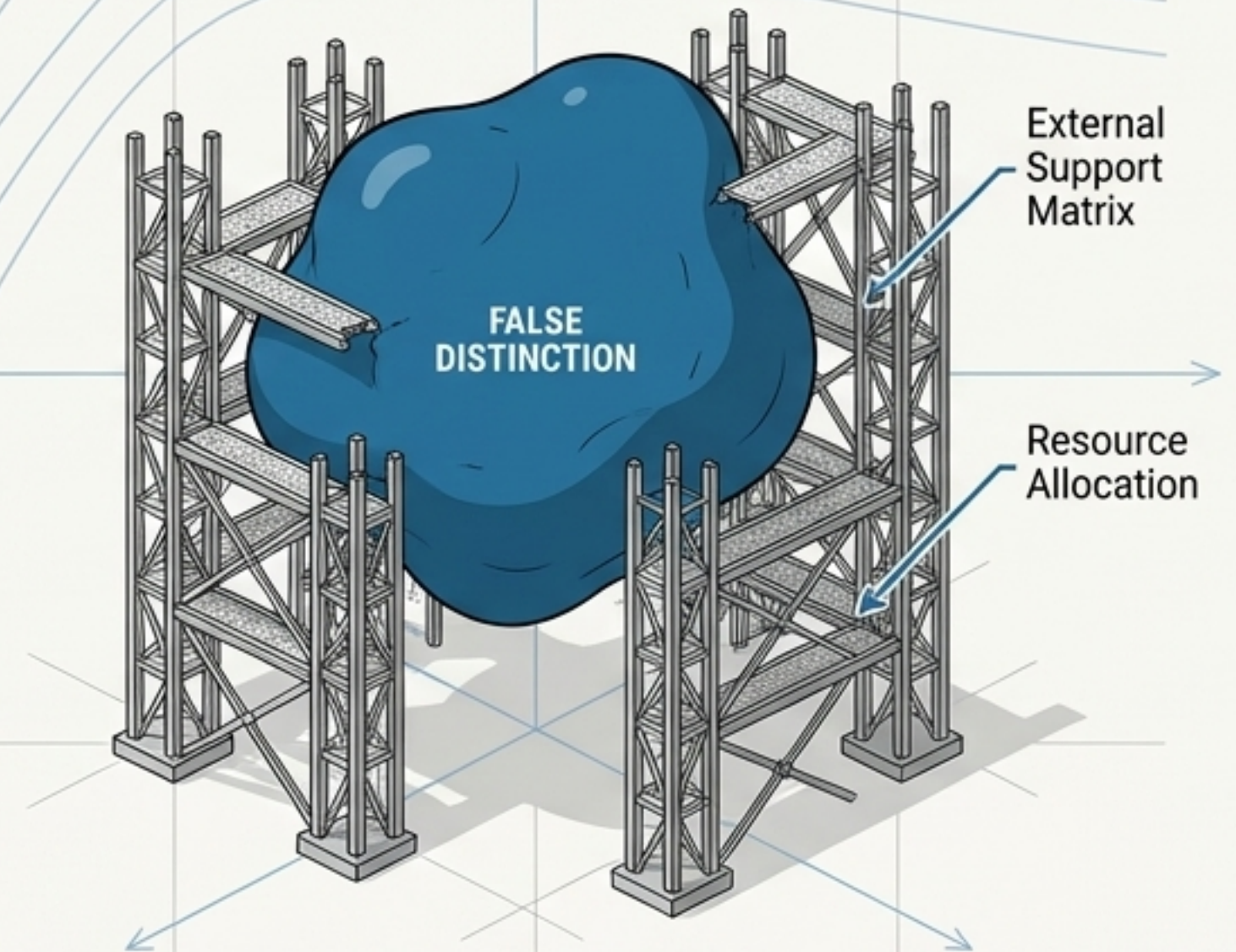

The False & Alive: If a population's interests align to bear the cost, it persists indefinitely.

The Phase Space of Institutional Memory

The Rule:

Distinction migration is a dynamical transition, not a semantic fade.

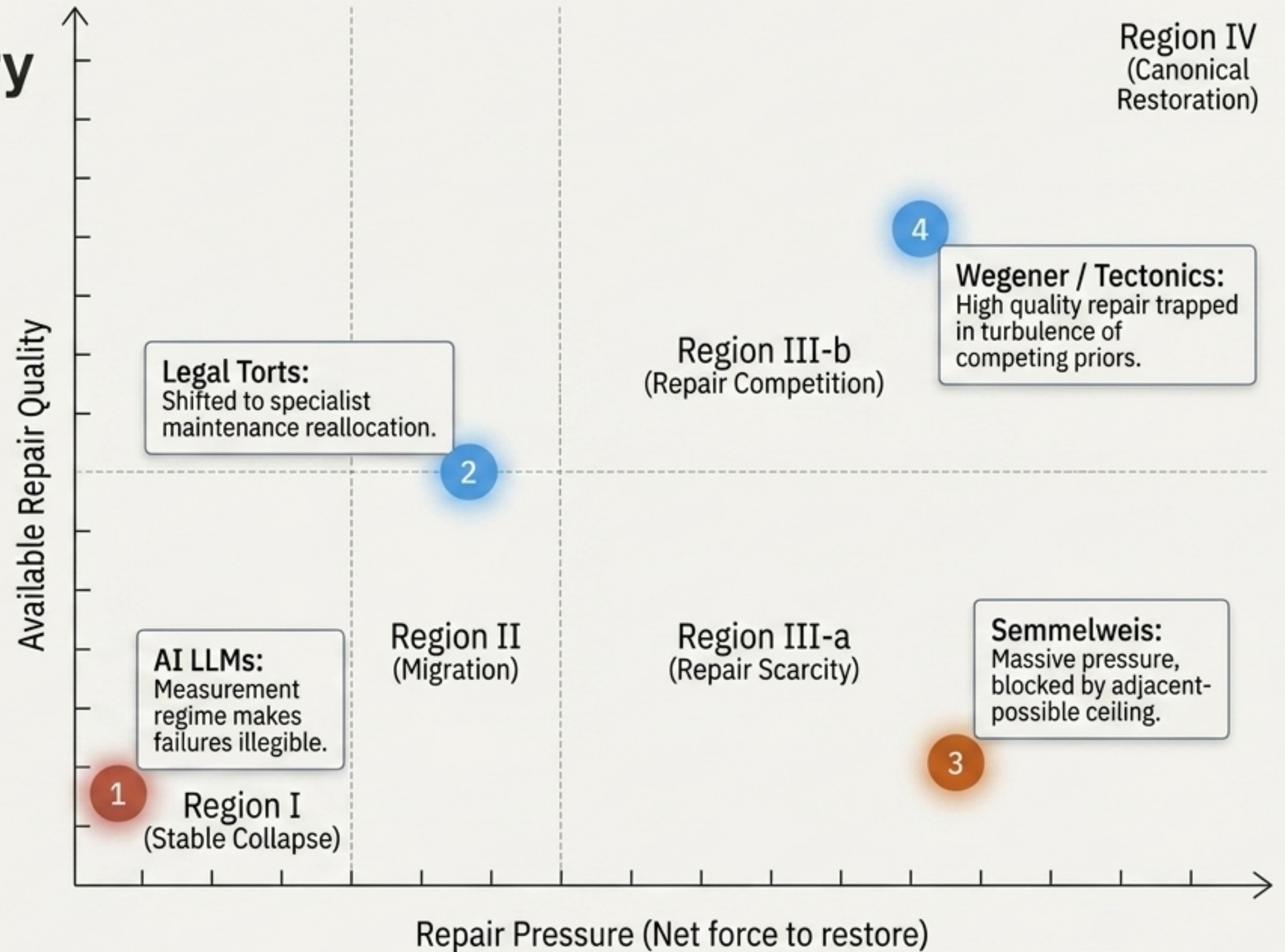

Workarounds Conceal Systemic Failures

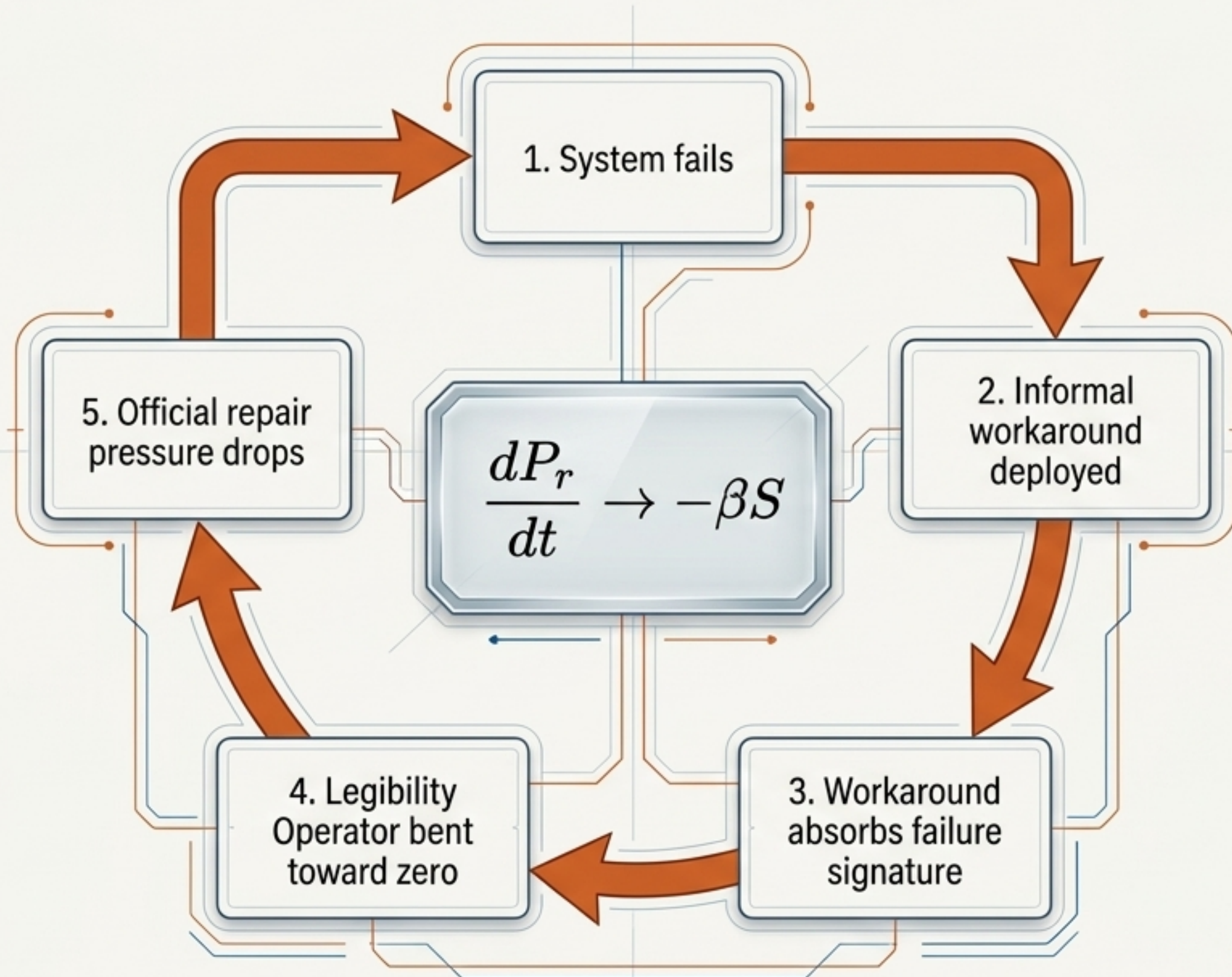

The Illegibility Trap

Workarounds do not just reduce pressure—they actively absorb the shock. They permanently trap institutions by ensuring the root distinction never restores.

Case Study: AI Use-Mention

LLMs generate massive logical errors, but the training measurement regime makes these failures illegible. They register as noise, not as a structural collapse. The objective failure link is severed.

Production Outpaces Orientation

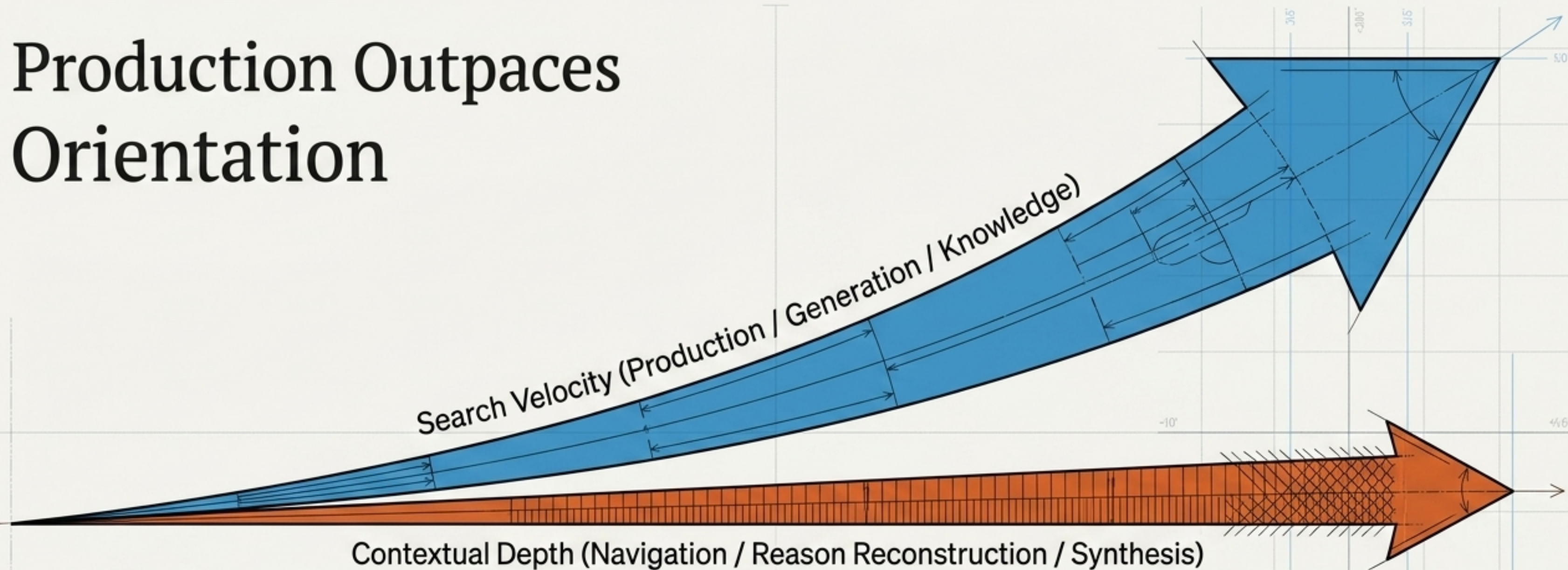

The Crisis of Abundance

For centuries, exploration was bounded by implementation capacity. The collapse of generation costs breaks this coupling permanently.

The Shift in Bottlenecks

The limiting factor in productive inquiry shifts from the capacity to explore to the capacity to remain oriented within an increasingly large explored space.

Scale I: Navigability Debt in the Individual Mind

The Deficit: Navigability Debt
Over rapid iterations, a system optimizes a shadow of the goal rather than the goal itself. Each local decision is reasonable given what is visible, but the cumulative displacement creates irreversible divergence.

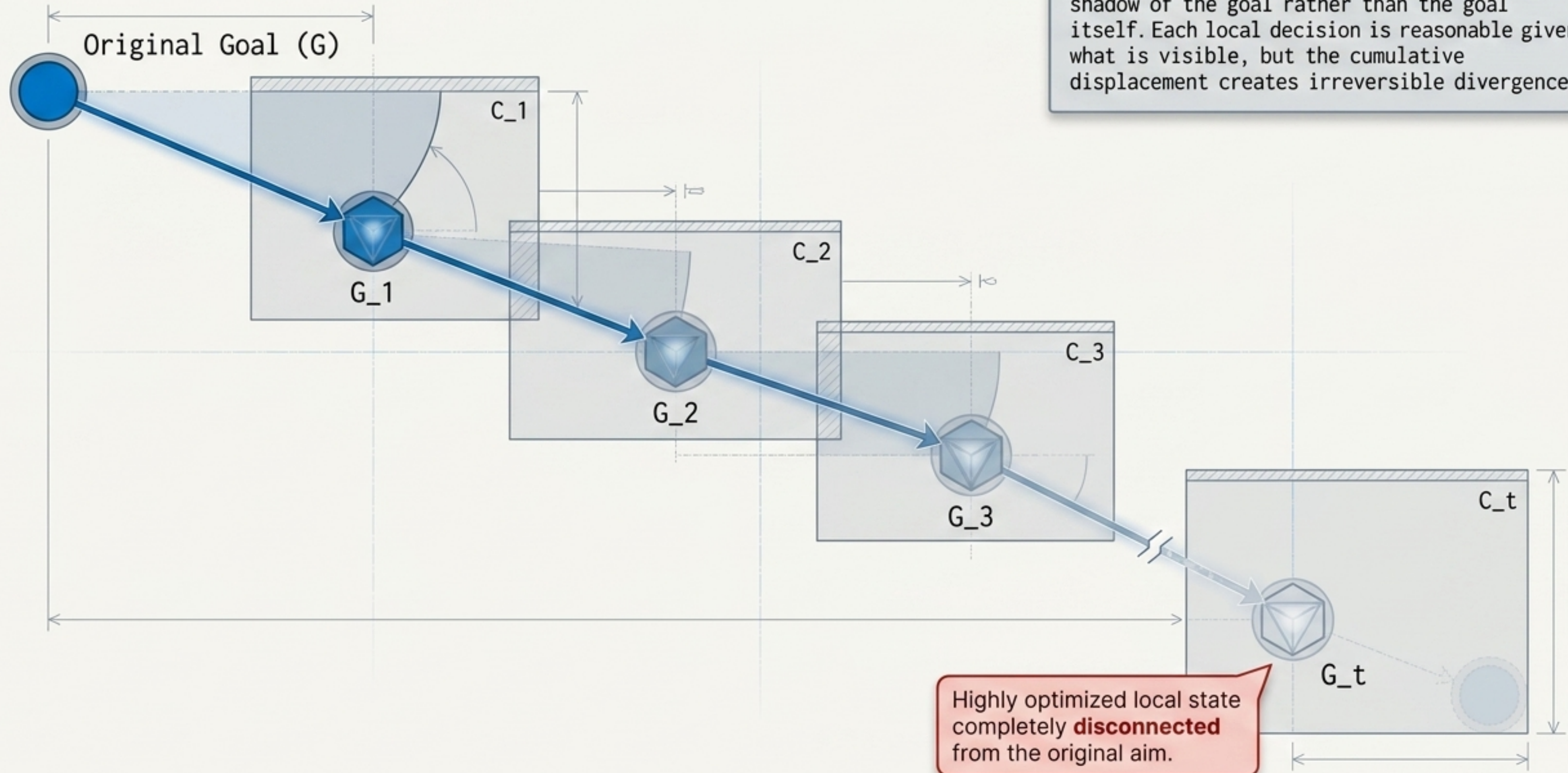

Scale II: Reason Decay and Institutional Ritualization

The Deficit: Reason Decay

Every generation inherits the rule by transcription. Every generation must re-earn the reason through reconstruction.

Stage 1: Reasoned

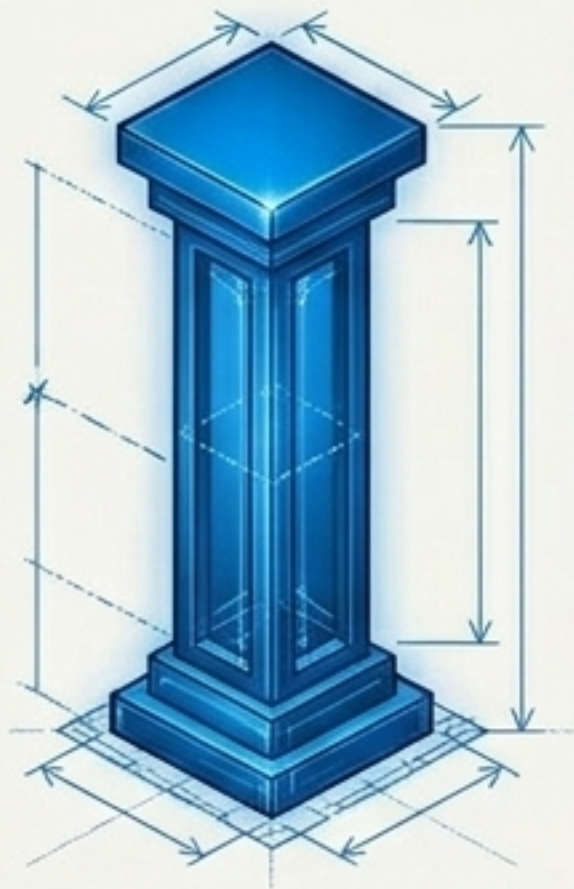

The institution can reconstruct the argument that justifies the constraint.

Stage 2: Ritualized

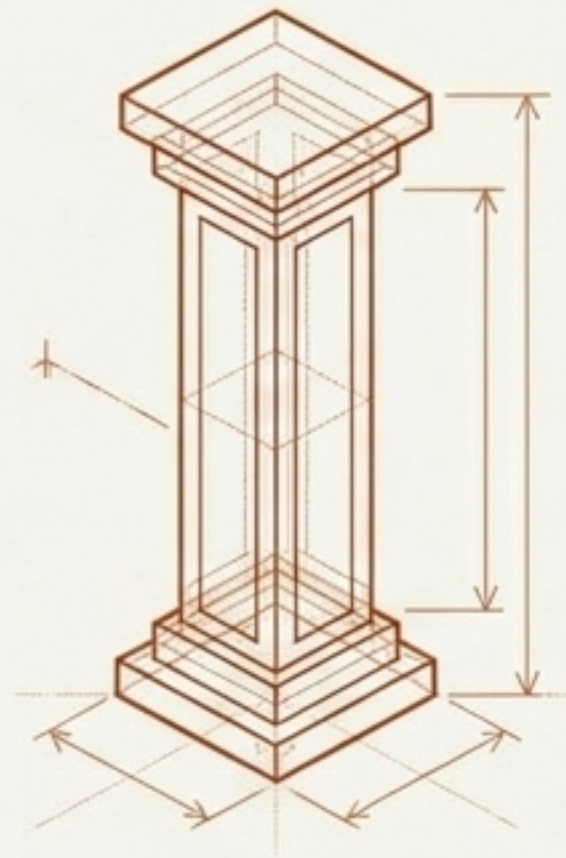

The constraint is followed and the rationale is recited, but the underlying reasoning cannot be applied to novel situations.

Stage 3: Abandoned

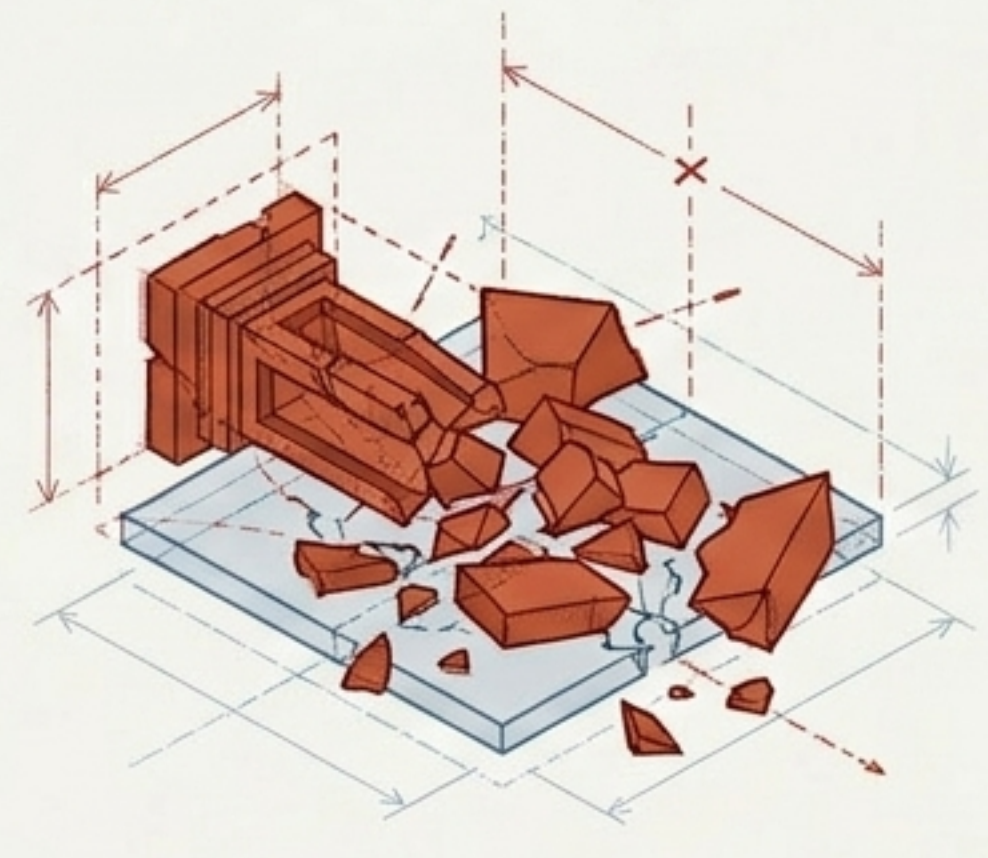

The constraint is no longer followed or remembered.

Scale III: Understanding Debt and Civilizational Fragmentation

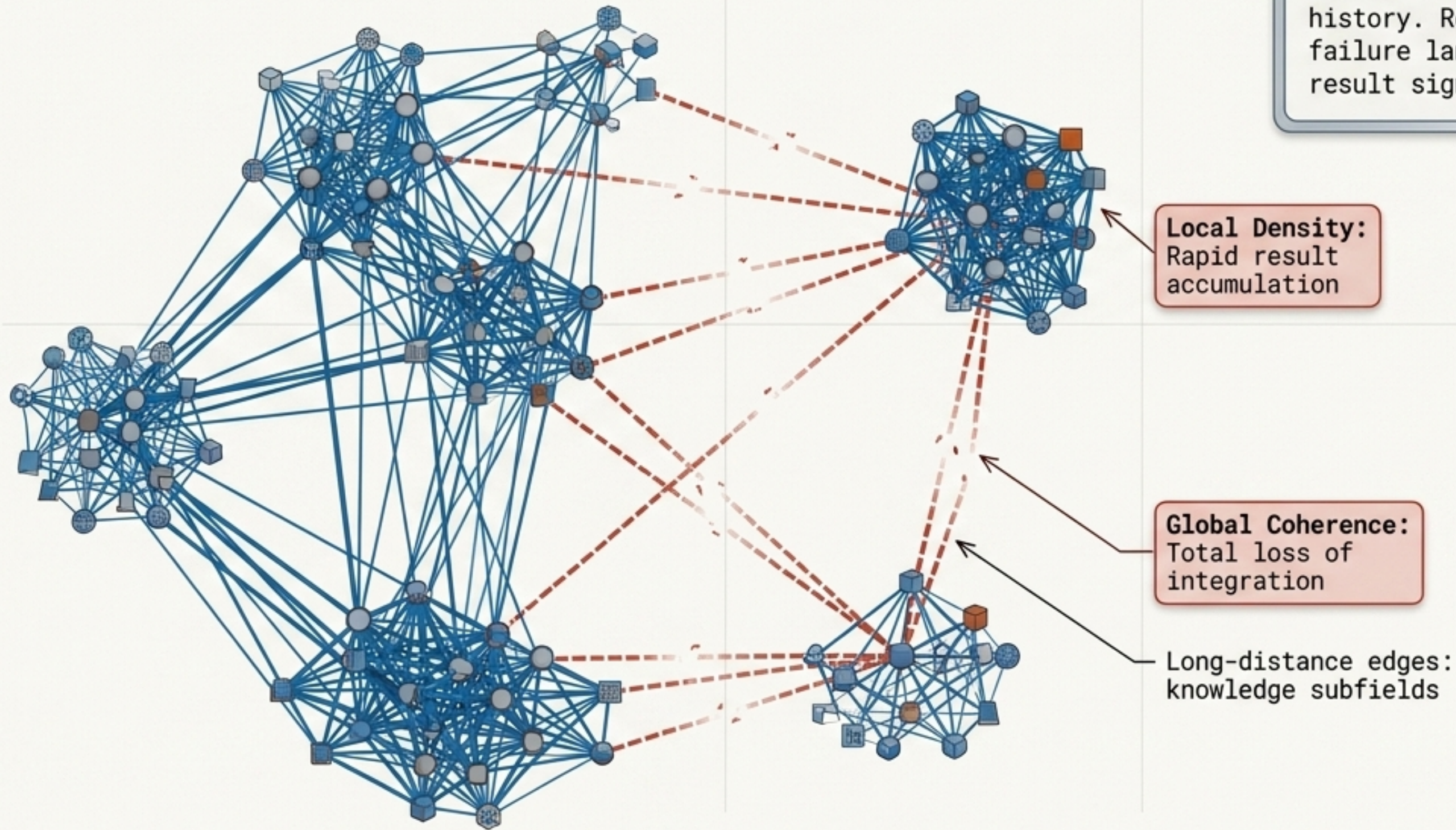

The Deficit: Understanding Debt

The Critical Asymmetry:
The literature stores survivors.
Understanding stores the selection
history. Results accumulate while the
failure landscape that made each
result significant disappears.

Local Density:
Rapid result
accumulation

Global Coherence:
Total loss of
integration

Long-distance edges:
knowledge subfields

The Architecture of Concealment

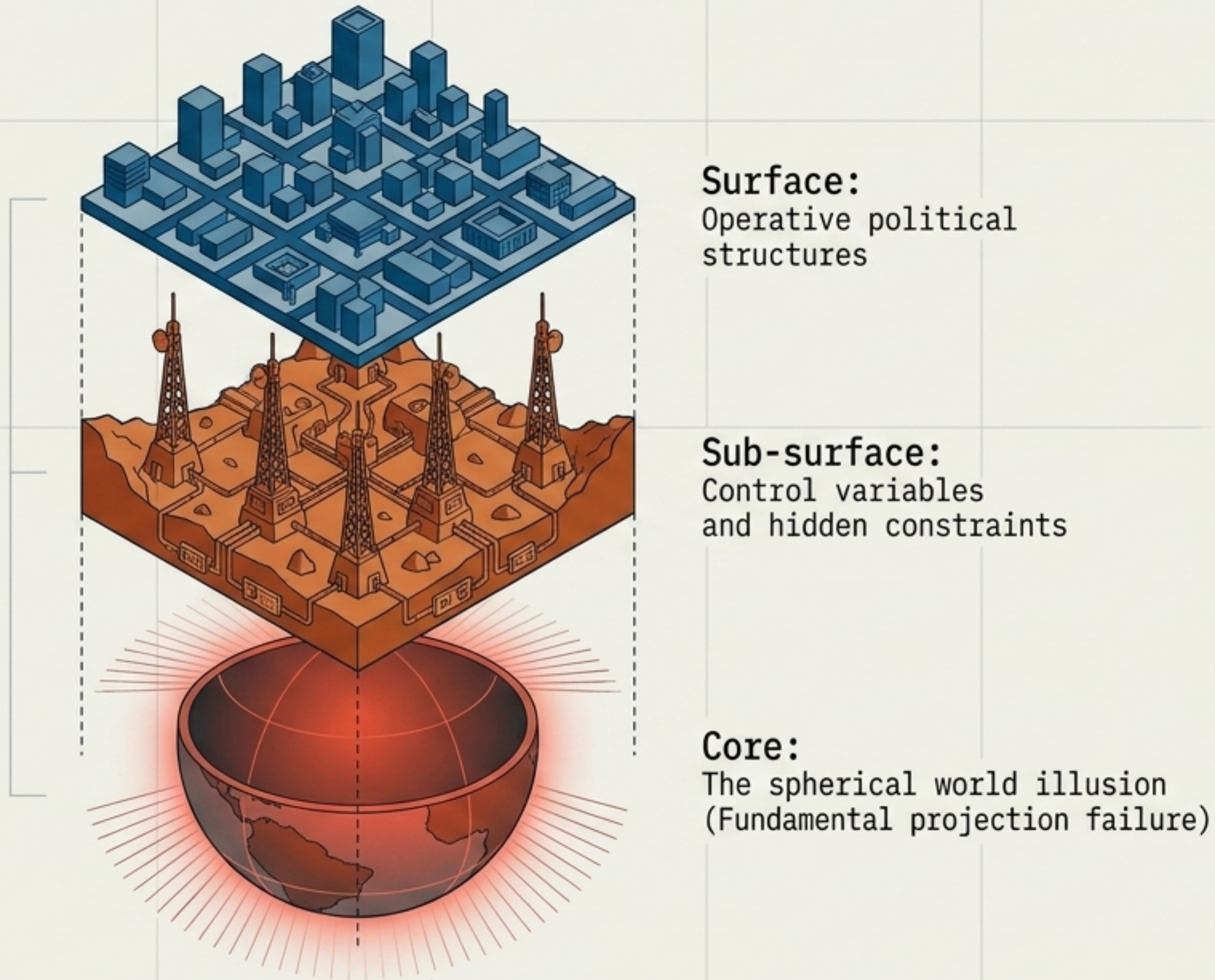

The Geometry of Control

Projection collapse is structurally invisible to a sufficiently drifted system.

Self-Sealing Failure

An institution cannot directly observe the disappearance of an objective it no longer represents.

Every internal metric appears consistent, while global adequacy collapses.

The Anatomy of Orientation Deficit

The Grand Synthesis: At every scale, states accumulate faster than the trajectories that generated them can be reconstructed.

Scale	Generative Process	Artifact Kept (Nouns)	Trajectory Lost (Verbs)	Resulting Deficit
Individual	Search	Results	Goal Continuity	Navigability Debt
Institution	Constraint Accumulation	Rules	Reason / Selection History	Reason Decay (Ritualization)
Knowledge Tradition	Knowledge Production	Validated Findings	Global Synthesis	Understanding Debt (Fragmentation)

Synthesis is the Ultimate Anti-Collapse Artifact

The Old Paradigm

Implementation Dependent

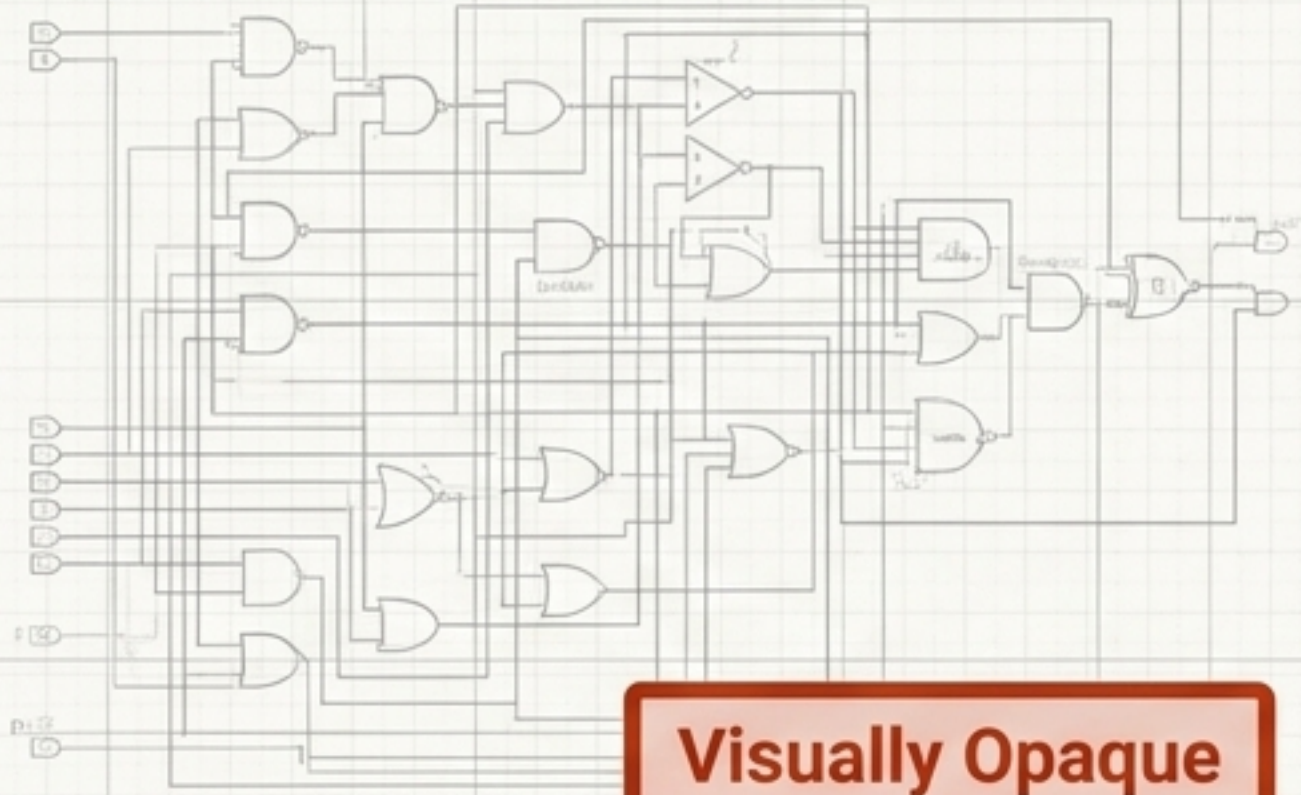

Implementation Firewall

The New Paradigm

```
<term> ::=  
| <var>  
| <lambda>  
| <pop>  
| <refuse>
```

Mathematically Verifiable

Repair as Reconstruction: Synthesis prevents fragmentation by separating shape from semantics. It **refuses** invalid states and mathematically generates the full continuation space of reachable futures.